

KELLENBERGER 100

THE UNIVERSAL PLATFORM
FOR CYLINDRICAL GRINDING



KELLENBERGER 100

THE UNIVERSAL PLATFORM FOR CYLINDRICAL GRINDING

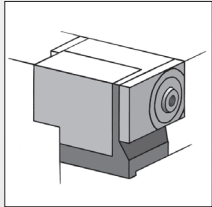

Universal workhead

- Applications with fixed or rotating spindle
- n 1-1'000 min-1
- Roundness accuracy $\leq 0.4 \mu\text{m}$ (optionally $\leq 0.2 \mu\text{m}$)
- Fine angle adjustment with correction range $\pm 1.5^\circ$

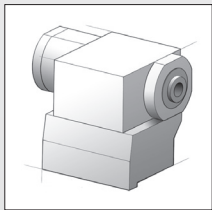

Workhead with direct drive and C axis

- For high-precision non-circular grinding
- n 1-1'000 min-1
- Roundness accuracy $\leq 0.4 \mu\text{m}$
- Base with fine angle adjustment with correcting range $\pm 1.5^\circ$

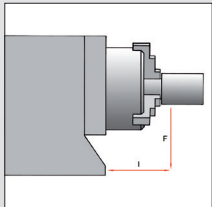

Load with chucked work

- 100 Nm (max 100 kg)
- 200 Nm with direct drive (max 150 kg)

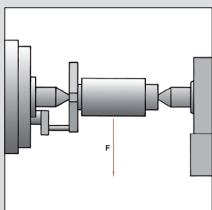

Load between centers

- 100 kg
- 150 kg with direct drive

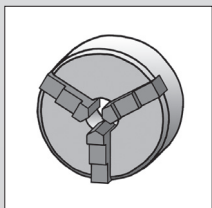

Power clamping system

- Clamping force 2'000-9'000 N
- Power-actuated chuck
- Spring collets



Transport

- Efficient commissioning due to different lifting options

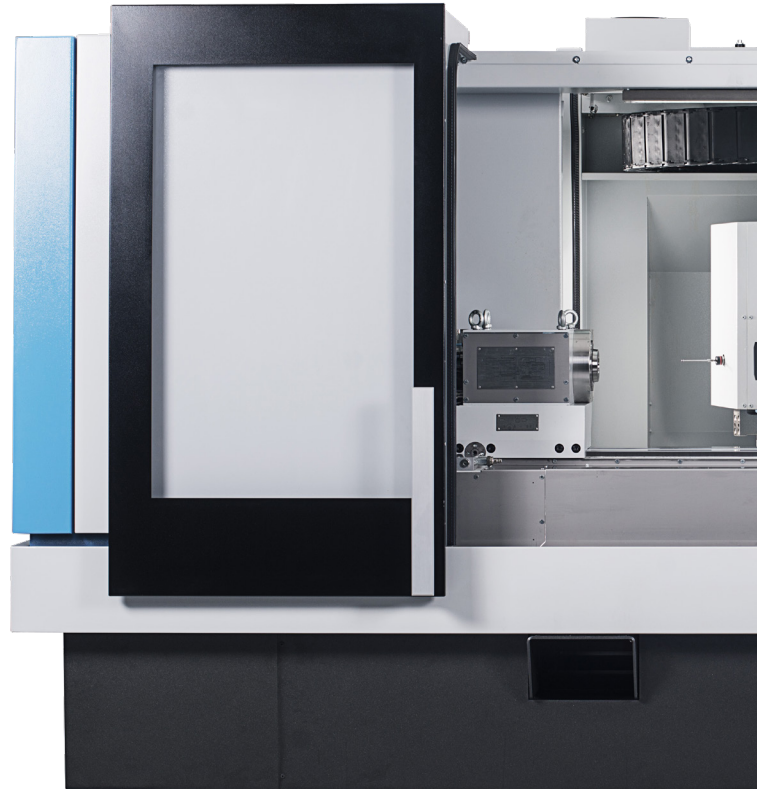

CNC-Control System Fanuc 31i-B

- 19" LCD color monitor with touch operation, height-adjustable
- BLUE Solution teach-programming with OBJECT Guide for guided and easy creation of programs on the workpiece
- IPC Windows Embedded Standard 7 operating system
- Hand-held panel with axis & speed selector
- Ethernet (RJ45) and USB 2.0 connections

Basis

- FEM-optimized cast machine bed for high stability and longevity
- Mechanical separation of machine and peripherals, for thermal stability and prevention of vibrations

Table / slide

- Linear guide for X axis, low maintenance, high precision, proven a 1'000 times over
- Low-wear slide guide for Z-axis with special anti-stick-slip coating, for high-precision machining of contours
- Glass measuring devices on X- and Z- axes
- High dynamics due to speeds of up to 20 m/min. in Z- and 10 m/min. in X-axis

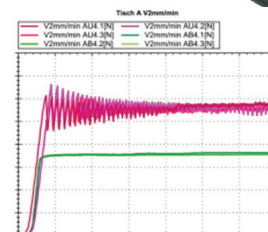
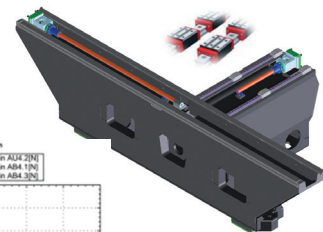

THE NEW DEFINITION OF A CNC CYLINDRICAL GRINDING MACHINE



Ergonomics

- Advanced optical and ergonomic design
- Good overview of the grinding process
- Interfaces for table assemblies arranged centrally and for ideal access
- Swiveling and height-adjustable control panel for optimized operating convenience
- Cleverly designed accessibility for

low-cost maintenance and service

Automation

- PROFIBUS interface and prepared mechanical infrastructure
- Synchronous tailstock for complete machining of shafts
- Loading cell with highly autonomous operation and quick setup times
- Project-specific solutions can be realized by request

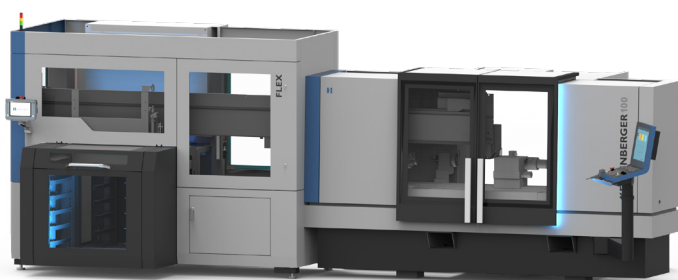

Tailstock 100

- Up to 100 kg workpiece weight
- Morse taper 4
- Retraction of sleeve 49 mm
- Adjustment range $\pm 30 \mu\text{m}$
- Pneumatic lifting

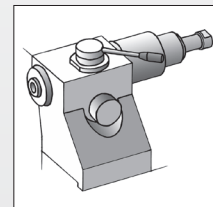

Tailstock 150

- Up to 150 kg workpiece weight
- Morse taper 4
- Retraction of sleeve 49 mm
- Adjustment range $\pm 75 \mu\text{m}$
- Pneumatic lifting

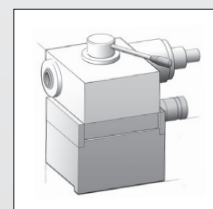

Synchronous tailstock

- Machining of shaft parts without driver
- Sleeve with MT4 and 49 mm retraction
- Adjustment range $\pm 75 \mu\text{m}$
- Automatic cylinder correction (optional)

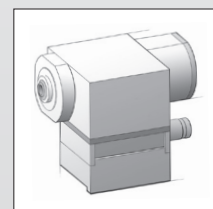

HF dressing device

- For rotating dressing tools
- Behind table assemblies
- On the table

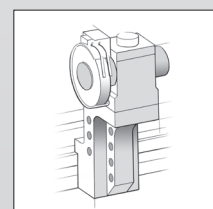

Automated sliding doors

- Relief for the operator
- Faster workpiece changeover times

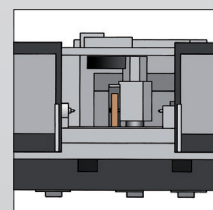

MODULAR WHEELHEAD SYSTEMS

COMPACT AND INNOVATIVE

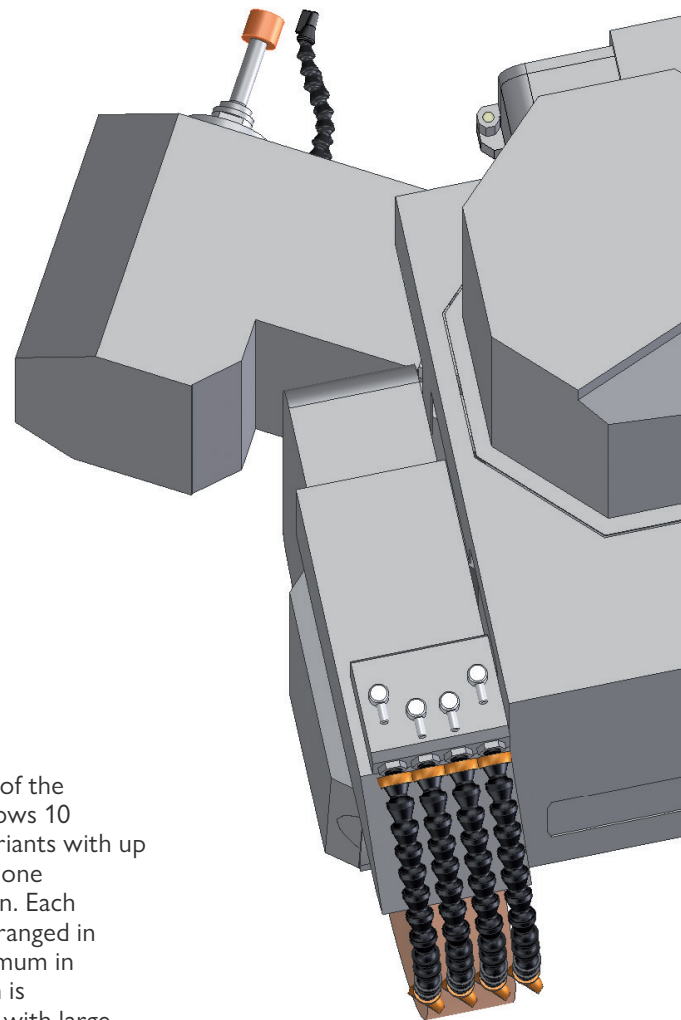
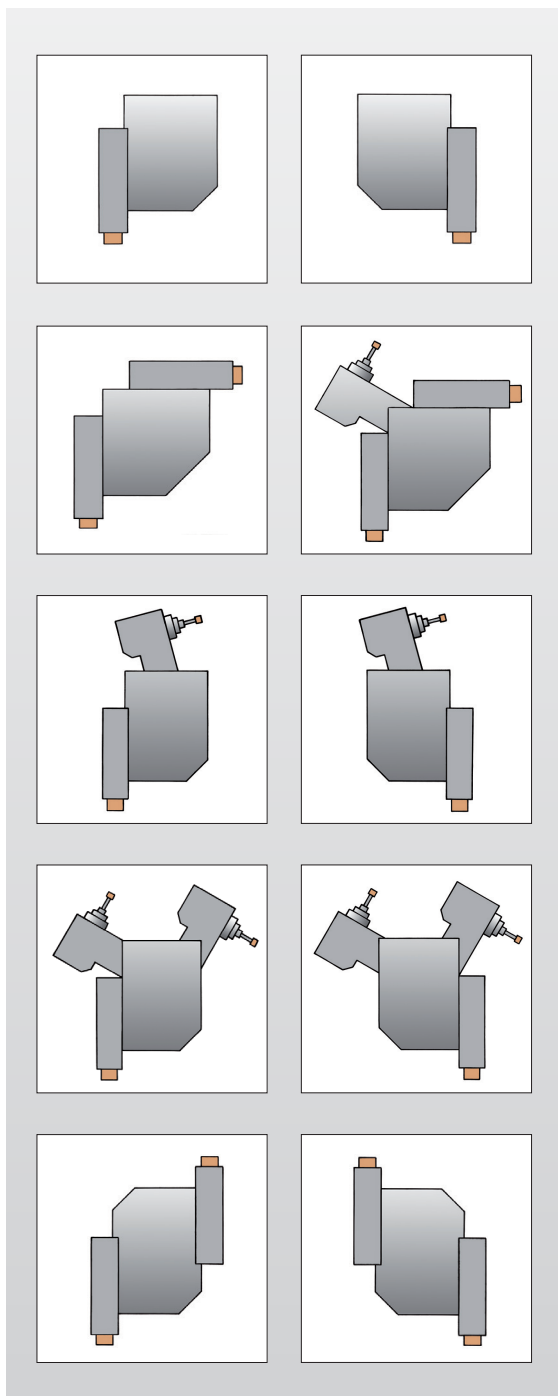

Wheelhead

The ingenious concept of the modular wheelhead allows 10 different wheelhead variants with up to 3 tool positions and one measuring head position. Each individual position is arranged in such a way that a maximum in collision-free operation is guaranteed. Combined with large axis paths, an optimum in flexibility is achieved in the machining of workpieces of different sizes.

- External grinding with water-cooled motor spindles and 11.5 kW power
- Special oil lubrication guarantees long service life
- Grinding wheel dimensions up to $\varnothing 500 \times 100$ mm
- High-frequency internal grinding spindles, available as grease-lubricated or oil-air-lubricated models
- 150 mm mounting bore allows internal grinding spindles with large radial rigidity

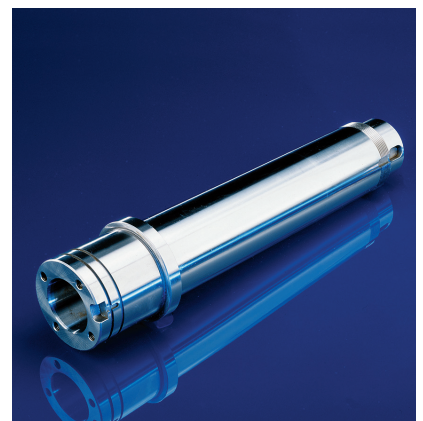

INTERNAL GRINDING / SWIVEL DEVICES & ACCESSORIES

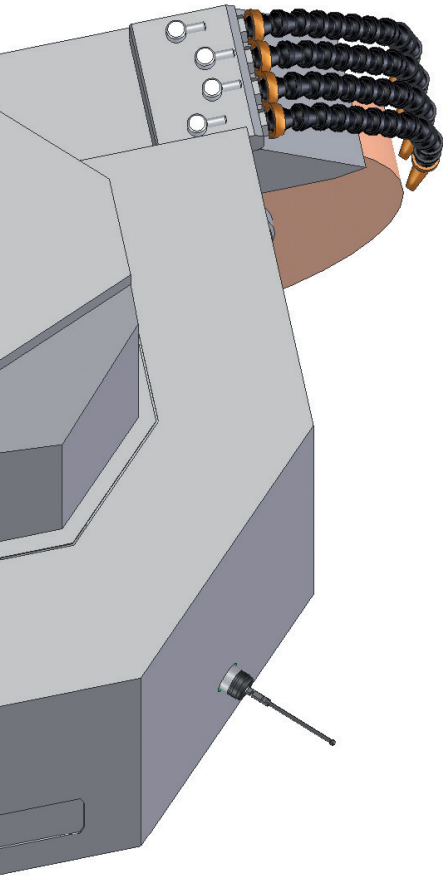

Swivel devices

Two versions are available for fast positioning the wheelhead (tool change time approx. 5s):

- 1° indexing with automatic drive or
- B-axis with direct drive with resolution of 0.00001° and a repeatability of <0.5" incl. gSet (patented grinding wheel measurement)

Accessories

- Tactile measuring head, fastened rigidly on wheelhead, for active measuring tasks
- Integrated lifting system for grinding wheel changeover and for lifting table assemblies; saves having a crane at the machine
- Various steady-rests, also including guiding steady-rests for grinding

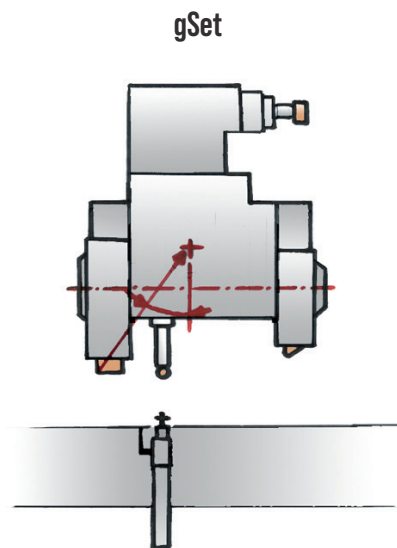

Internal grinding attachment

- Grease-lubricated HF internal grinding spindle 6'000 - 40'000 min⁻¹ 10'000 - 60'000 min⁻¹
- Inexpensive and compact

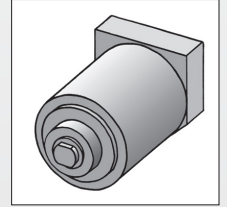

Internal grinding attachment

- Oil-air lubricated HF internal grinding spindle 4'500 - 45'000 min⁻¹ 8'000 - 60'000 min⁻¹ 12'000 - 90'000 min⁻¹
- Powerful and universal

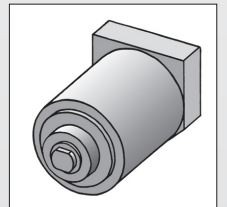

Swivel devices

- Automatic indexing 1°
- B axis with direct drive (optional)
- Quick tool changeover time and high-precision positioning

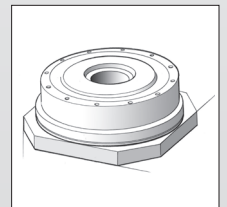

Tactile measuring head

- Active measurement on external machining
- Orientation of the workpiece position in Z- and C-position
- Mounted on wheelhead

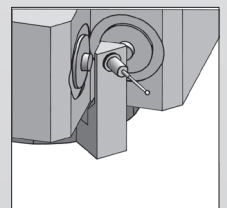

Integrated lifting system

- Ergonomic lifting system for table assemblies and grinding wheels

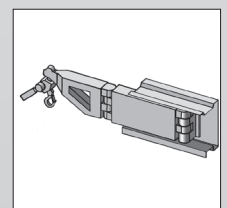

FANUC CONTROL 31i-B

WITH KELLENBERGER HMI

The BLUE Solution user interface from KELLENBERGER has the central focus on simple and intuitive operation. All interactions are carried out by gestures on the 19" touch display. The latest generation of a reliable FANUC 31i-B control runs in the background.

Blue Solution



The user interface was developed explicitly for grinding by our specialists in cooperation with customers. BLUE Solution supports users regardless of their level of experience in all important steps from setup to production.

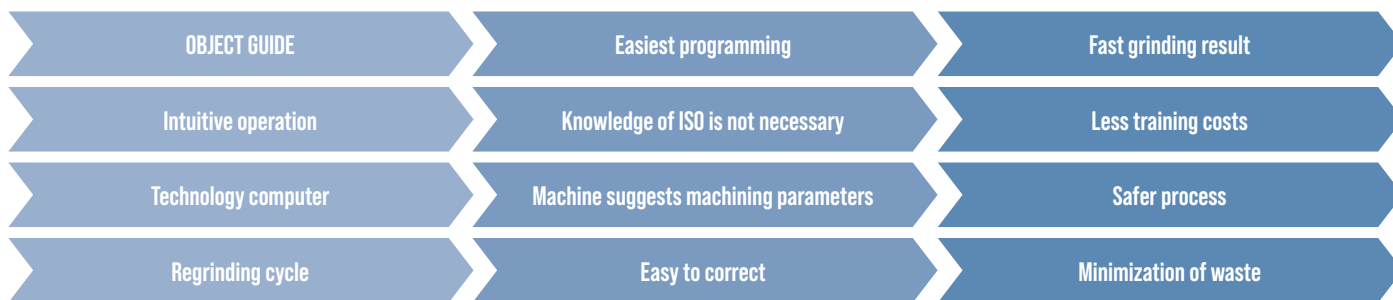

BLACK CAM SOLUTION

With the additional BLACK CAM Solution software, NC programs for grinding and dressing of profiles and threads can be generated, simulated and analyzed.

The CAD-CAM software supports the structured creation, processing and management of all documents belonging to a workpiece.

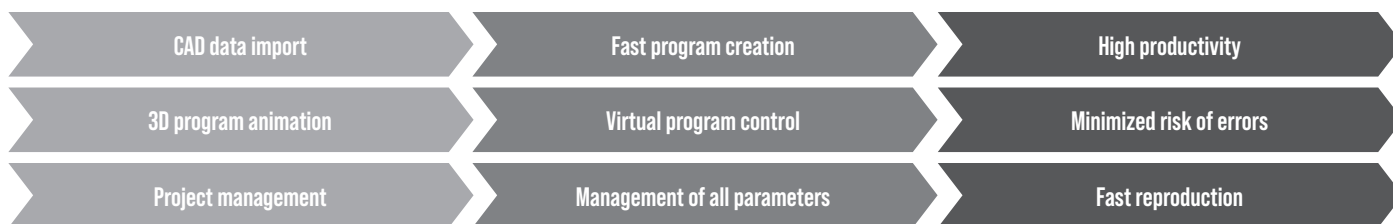
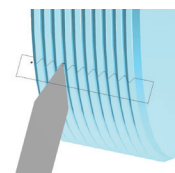

INDUSTRY 4.0

The Security Interface ensures communication according to the highest IT security standard between the machine and the production network.

The optional Remote Diagnostic module simplifies efficient diagnosis in case of service and thus reduces downtimes.

The machine is prepared for Industry 4.0. With the ComGateway, which has a standard OPC-UA server, extensive information on process and machine status can be exchanged.



TECHNICAL DATA

Main Specifications		
Distance Between Centers	mm	600 / 1,000
Center High	mm	200 / 250
Loading capacity, between centres:	kg	100 / 150
Spindle loading capacity, chucked:	Nm	100 / 200
Mains Voltage Required	V	380 / 400 / 460
Power Consumption	A	35-63
Space Required / length x width	m	2620 x 2170 / 3400 x 2170
Total Weight	kg	3,600 /4,000
Longitudinal / Slide Z-Axis		
Travel	mm	750 mm / 1150 mm
Rapid Traverse Speed	m/min	20 m/min
Resolution	mm	0.00001
Wheelside X-Axis		
Travel	mm	365
Rapid Transverse Speed	m/min	10 m/min
Resolution	mm	0.00001
B-Axis		
Swiveling Range	Degree	280°
Swiveling Time	Sec	1
Automatic Indexing	Degree	1
System Resolution	Degree	0.00001°
Wheelhead		
Water-Cooled Motor Spindle	KW	11.5
Peripheral Grinding Wheel Speed	m/s	50 / 63 (option)
Grinding Wheel Dimensions	mm	Ø500
Internal Grinding Attachment		
Bore for Spindle	mm	150
Power, HF 51 Spindles	KW	4.2 - 15
Rotation Speed	min-1	4,500 - 90,000
Workhead		
System Resolution C-Axis	Degree	0.00001
Rotation Spindle Speed	min-1	1 - 1,000
Drive Torque	Nm	up to 63
Interface		ISO 702-1, Gr .5/MK5
Roundness Accuracy in Chucked Work	µm	optional 0.2
Tailstock		
Internal Taper		MK4
Retraction of Sleeve	mm	49
Option micro-adjustment	µm	+/- 30 and +/- 75

All specifications and designs are subject to alterations without notice

Setup plan 600

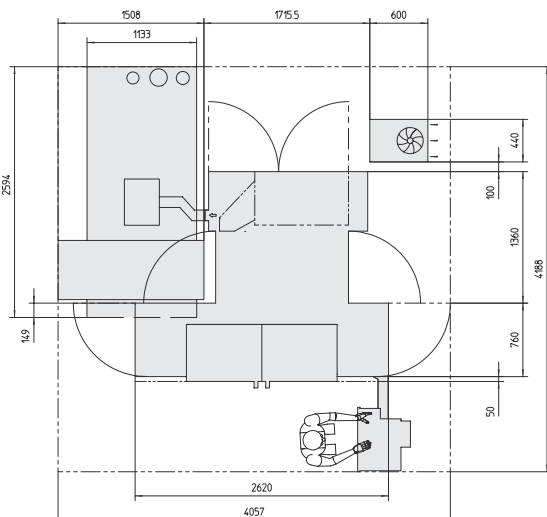

Setup plan 1000

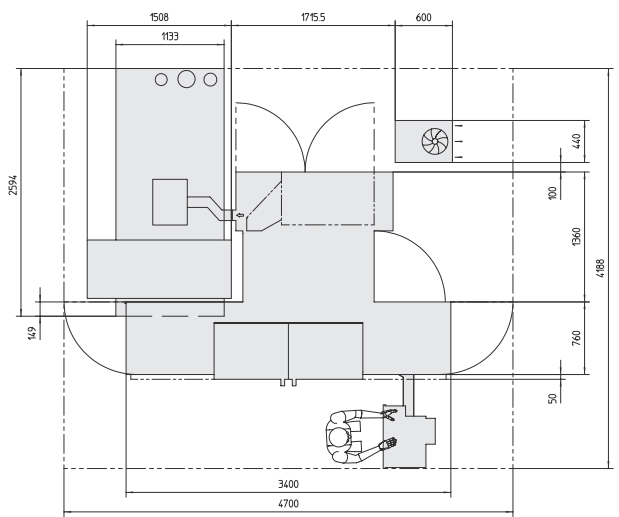



EUROPE & ASIA

Kellenberger Switzerland AG
Thannäckerstrasse 22
9403 Goldach
Tel. +41 71 242 91 11
info@kellenberger.net

AMERICA

Kellenberger Systems
1755 Britannia Drive, Unit A
Elgin, Illinois 60124
Tel. +800 8438801
info@kellenberger.net

CHINA

Kellenberger
1388 East Kang Qiao Road
Pudong, Shanghai 201319
Tel. +86 21 38108686
info@kellenberger.net

All prices and details are subject to change without notice. 1/2025

kellenberger.com

