

KELLENBERGER 1000

THE UNIVERSAL PLATFORM
FOR CYLINDRICAL GRINDING



KELLENBERGER 1000

CYLINDRICAL GRINDING SYSTEMS FOR THE HIGHEST DEMANDS

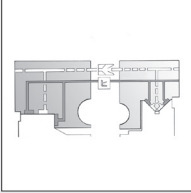

HYDROSTATICS

- X and Z guideways
- No stick-slip, no wear
- Good damping
- Ultra-fine correction options

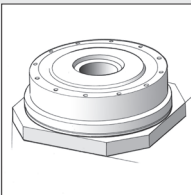

HYDROSTATIC B-AXIS

- Full-fledged NC axis
- Pre-tensioned hydrostatic guideway
- Direct drive

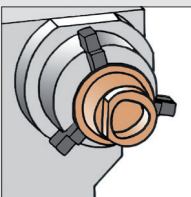

C-AXIS

- For non-circular workpieces
- For threads
- High-precision spindle bearing
- Direct drive
- High flexibility

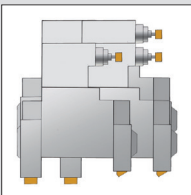

PLATFORM CONCEPT FOR MORE THAN 20 DIFFERENT WHEELHEADS

- Universal wheelheads
- Diagonal wheelheads
- Tandem wheelheads
- Various mounting positions

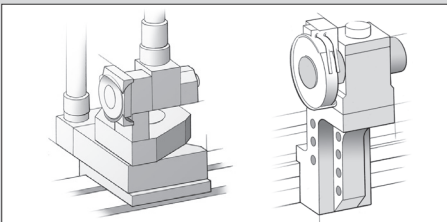

DRESSING SYSTEMS

- Independent interface at table
- Swiveling unit for chucked work
- Fixed diamonds
- Form and profile dressers



PRECISION WITH HYDROSTATICS

Hydrostatic guideways and a strict separation of the machine base from the assemblies, generating heat or vibration, provide superb precision and productivity.

The excellent static and dynamic rigidity of the machine base permits a three-point set-up. The Kellenberger 1000 therefore has no particular requirements on the building's foundations. The hydrostatic guides for the longitudinal slide movement (Z-axis) and for wheelslide infeed (X-axis) provide the basis for the machine's extreme accuracy. X- and Z-axis movements are practically frictionless at all speeds. There is no stick slip; even the smallest increments of 0.1 μm can be traveled without a problem, so that the machine features measuring-machine accuracy.

LARGE WORK SPACE – UNIQUE TABLE CONCEPT

The machine table has been considerably extended so it allows unmatched, optimal positioning of the grinding wheel and a larger travel distance, but also many machining options and application-specific configurations.

FUNCTIONAL MACHINE CASING

The increased sheet metal thickness means even more process reliability, allowing larger internal grinding wheel diameter of up to 125 mm. With their large viewing windows, the generously-sized doors allow optimum control over the work process and make it easier to access the work space. The genuine glass laminated safety panes require very little maintenance.

FUNCTIONAL DESIGN WITH HIGHLY PRECISE TECHNOLOGY



COMPACT AND MAINTENANCE-FRIENDLY

Elements such as the power supply, electrical cabinet, and a central connection point for cooling lubricant, cooling system, and pneumatics were all integrated into the casing. Service and maintenance doors for unimpeded access to machine components are integrated into the back.

OPTIMIZED ENERGY MANAGEMENT

Performance-optimized central cooling system. Automated procedures for switching on and off. Energy-efficient low-pressure hydrostatics. Improved stand-by modes

EASY COMMISSIONING

The integrated transportation concept shortens commissioning times considerably.

MACHINE RE-COOLING

- Comprehensive cooling system with needs-based design (wheelhead & grinding spindles, direct drive, hydrostatics, electric control cabinet)
- Increased flow rates at lower system pressure
- Active cooling principle for optimal temperature stability
- Minimized thermal drift, so smaller deviations on workpiece
- Hydrostatic oil cooled to ambient temperature
- Automatic tracking of surroundings, water cooler: Sensor in bed measures reference temperature of regulator

OPTIONS

- Increased coolant pressure up to 10 bar
- Interface for automation
- Automatic door drive
- Lifting system for grinding wheels

CONTROL SYSTEM

- FANUC 31i-B
- 19" Touch Screen



BLUE SOLUTION

- Set-up
- Programming with gSHAPE
- Production



X/C INTERPOLATION

- Non-circular workpieces
- Thread grinding
- Jig grinding

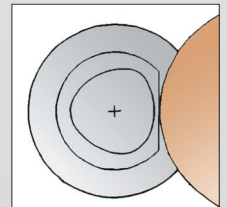

X/Z INTERPOLATION

- Taper grinding
- Profile grinding
- Profile dressing

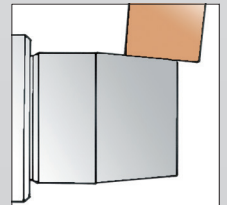

B-AXIS AND AUTOMATIC GRINDING WHEEL MEASURING SYSTEM

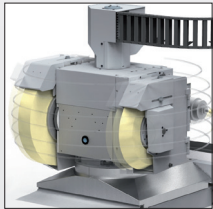

HYDROSTATIC B-AXIS

- Pre-tensioned hydrostatic guide
- The direct drive is wear-free
- 180° swiveling in one second

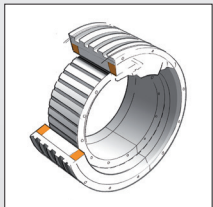

DIRECT DRIVE SYSTEM

- The water-cooled high-power motor guarantees a high level of torque
- The rotary encoder is integrated in the absolute measuring system of the machine and requires no referencing

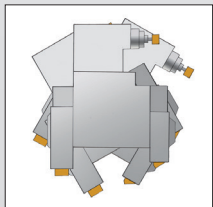

CLAMPING

- The B-axis can be clamped in any position without any deformation
- The large dimensions of the clamps guarantee high clamping moment

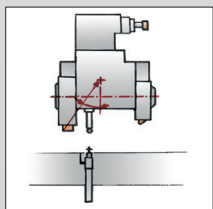

gSET

- Automatic grinding wheel measuring system

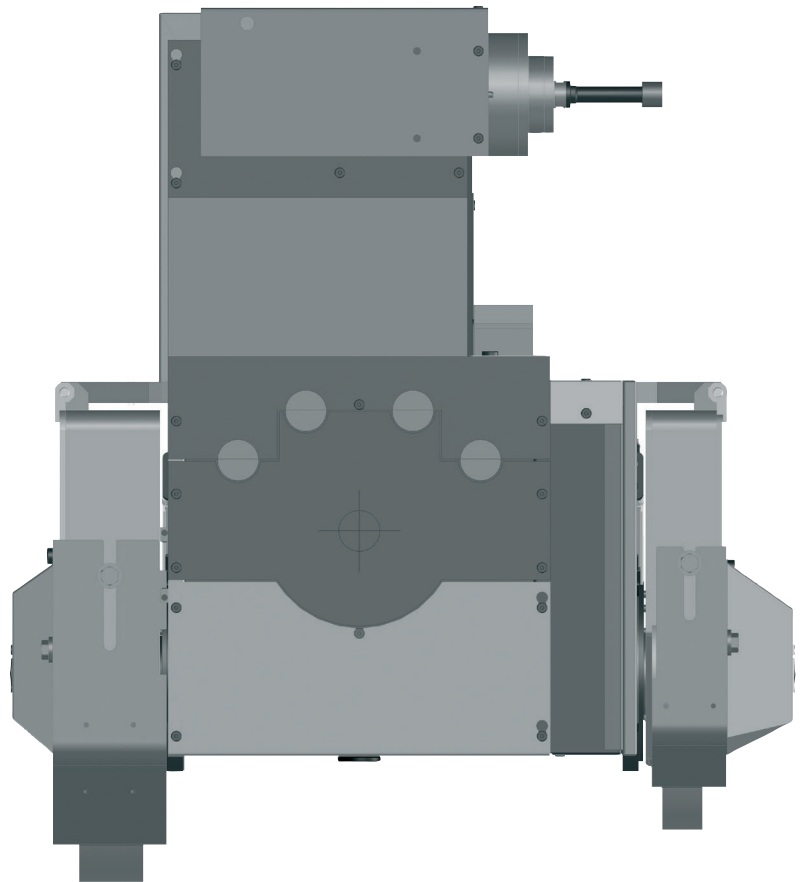

HYDROSTATIC B-AXIS

Full-fledged NC-axis with pre-tensioned hydrostatic guideway and direct drive.

The pre-tensioned hydrostatic is the basis for higher accuracy and better surface quality. In addition, it features a system resolution of 0.00001° and a repeatability of <math><0.5''</math>.

gSET

Automatic grinding wheel measuring system. Movements to the measuring ball and to the grinding wheels occur automatically, with their position information being stored in the control system. When swiveling the wheelhead into any angle, the positions of the grinding wheel edges are automatically taken into account.

ADVANTAGES FOR THE USER

- Programming takes place with the actual dimensions according to the work drawings and independently of the swivel angle of the wheelhead

- No need for renewed calibration of the swiveled grinding wheel
- Simple and fast acquisition of the grinding wheel data when retooling the machine
- Integrated tool management for external, face and internal grinding

WORKHEAD

Robust and rigid design on a solid base. Strong motor. Infinitely variable spindle speed. Airlock seals prevent ingress of dirt or water as well as the formation of condensation.

- Excellent roundness and dimensional accuracy thanks to pre-tensioned high-precision antifriction bearings
- Roundness of the workpiece $dR \leq 0.4 \mu\text{m}$ ($\leq 0.016 \mu\text{inch}$) on chucked work
- Versatile in use
- Comes standard with fine adjustment for cylinder correction for chuck work
- ISO 702-1 spindle nose

WORKHEAD, C-AXIS AND TAILSTOCK

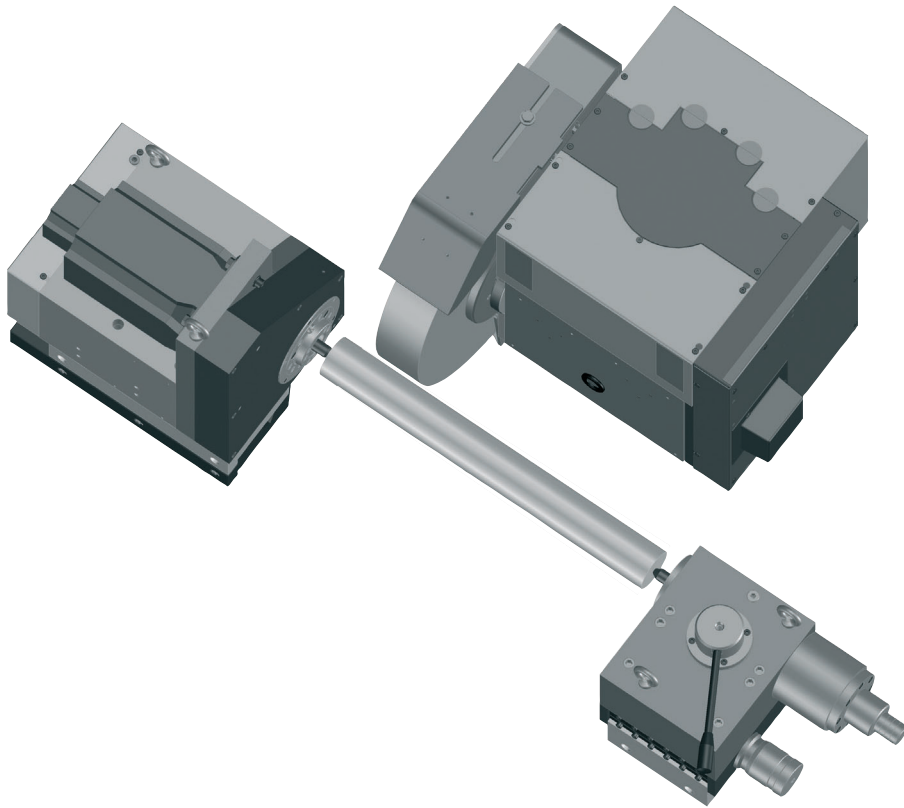

OPTIONS

- Roundness of the workpiece $dR \leq 0.2 \mu\text{m}$ ($\leq 0.008 \mu\text{inch}$) on chucked work
- Positioned spindle stop

C-AXIS

The option of interpolating the X- and C-axes makes it possible to use the cylindrical grinding machine also for unround shapes such as polygons, free contours and eccentric forms. The rotary encoder with a resolution of 0.0001° is installed directly on the workhead spindle. The non-circular movement is superimposed on the grinding movements so that the grinding machine can use all the grinding cycles on unround grinding too, including the handwheel release for the X-axis.

TAILSTOCK

The tailstock features a large and heavy design. The nitride-coated sleeve runs in sturdy ball-bush bearings.

- Excellent rigidity makes it possible to achieve high rates of infeed even with heavy workpieces
- Sensitive sleeve pressure adjustment
- Micro-corrector for quick and easy cylinder corrections
- Pneumatic relief for tailstock movement

OPTIONS

- Hydraulic or pneumatic sleeve retraction
- Automated cylinder correction
- Enlarged travel, 79 mm (3.14 inch)
- Reinforced design
- Retraction monitoring

WORKHEAD WITH DIRECT DRIVE

- n 1-1000 min⁻¹ with direct drive 200 Spindel nose ISO 702-1, size 5
- n 1-400 min⁻¹ with direct drive 300 Spindel nose ISO 702-1, size 8

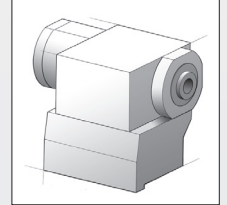

WORKHEAD

- Standard, n 1-1000 min⁻¹
- Spindel nose ISO 702-1, size 5
- As desired, with fixed or rotating center

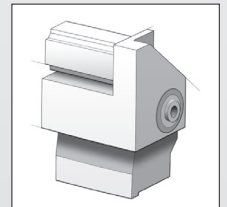

TAILSTOCK

- Morse taper 4
- Retraction of sleeve 49 mm (1.96 inch)

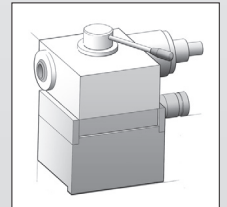

SYNCHRONIZED TAILSTOCK

- With integrated sleeve
- Morse taper 4
- Retraction of sleeve 49 mm (1.96 inch)

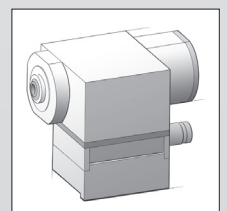

MICRO-ADJUSTMENT

- Adjustment range +/- 75 μm
- Optionally with automatic cylinder correction

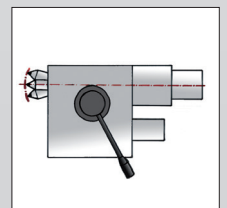

MODULAR WHEELHEAD VARIANTS

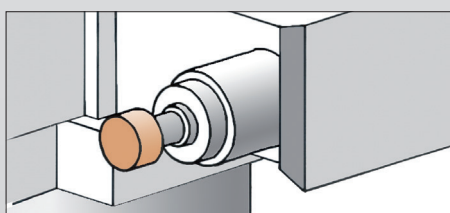
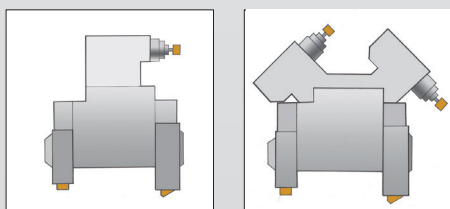
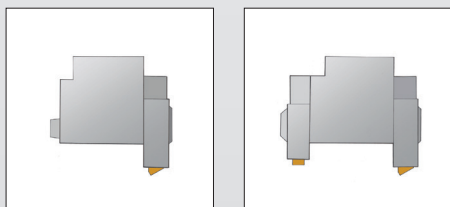
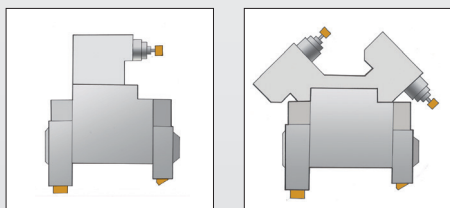
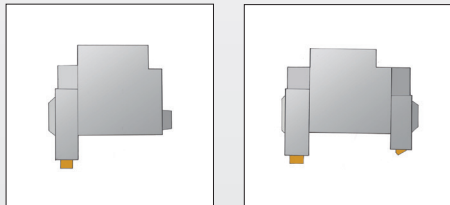

INTERNAL GRINDING ATTACHMENT

- High-frequency internal grinding spindle

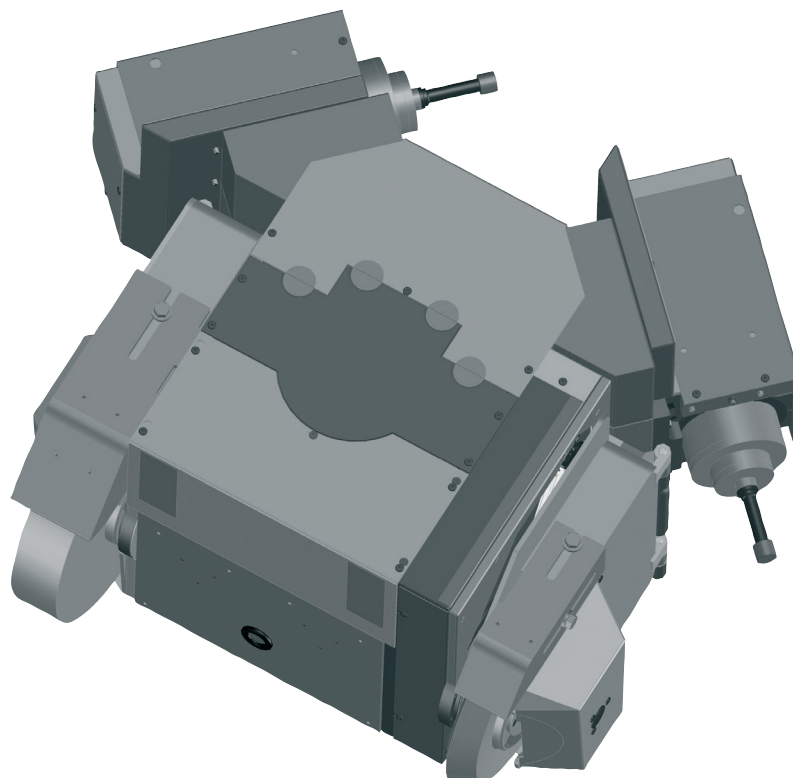

UNIVERSAL WHEELHEADS

- Motor output 10 kW (13.6 hp)
- Water-cooled precision-balanced drive motor
- Infinitely variable drive of OD and ID grinding spindles
- Hydrodynamic multi-surface spindle bearings
- Grinding wheel dimensions $\text{\O} 500 \times 100 \text{ mm}$ ($20 \times 3.15 \text{ inch}$)
- High-frequency ID grinding spindles

The universal wheelhead covers various user needs. In addition to external, face- and internal grinding, the use of two internal grinding spindles or the option of thread grinding or unround grinding are now increasingly in demand. Grinding in one setting allows shorter processing times and improves the quality of the workpieces considerably.

The new modular system makes it possible to supply the universal wheelhead to customer specifications, from a simple wheelhead with one tool to a configuration with up to four tools; see examples.

DIAGONAL WHEELHEADS

- Motor output 2x 10 kW (13.6 hp)
- Water-cooled precision-balanced drive motors
- Infinitely variable drive of OD and ID grinding spindles
- Hydrodynamic multi-surface spindle bearings
- Grinding wheel dimensions $2 \times \text{\O} 500 \times 100 \text{ mm}$ ($20 \times 3.15 \text{ inch}$)
- High-frequency ID grinding spindles
- Min. 2 OD grinding wheels
- Max. 2 OD grinding wheels and 2 HF ID grinding spindles

The diagonal wheelheads provide the option of rough and finish grinding in one setting. The additional use of HF ID grinding spindles also allows universal OD, face-and ID grinding.

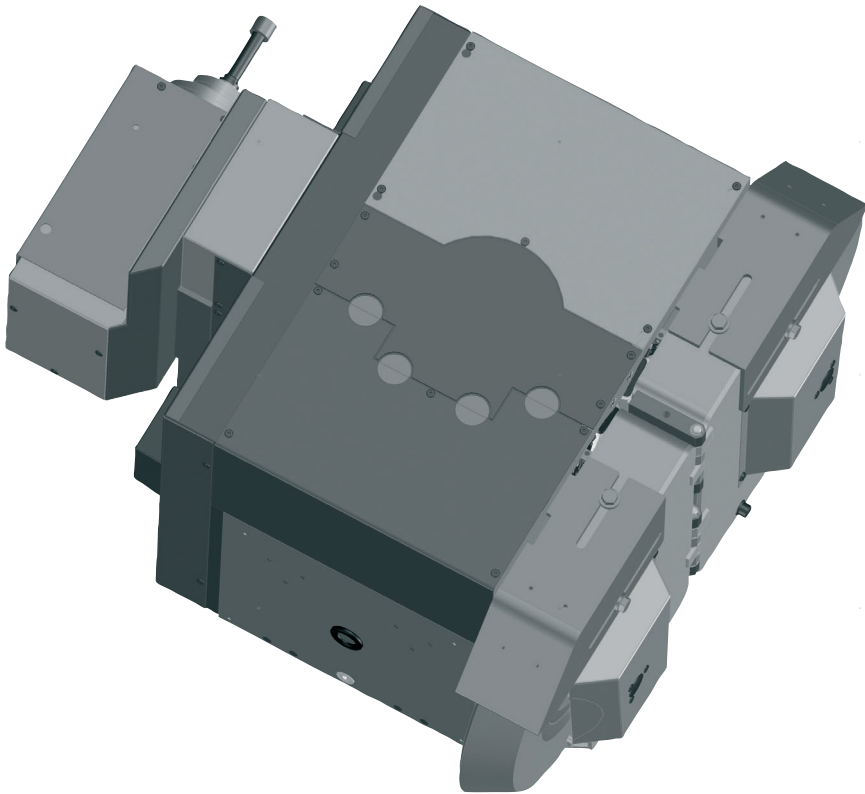

TANDEM-TYPE WHEELHEADS

- Motor output 2x 10 kW (13.6 hp)
- Water-cooled precision-balanced drive motors
- Infinitely variable drive of OD and ID grinding spindles
- Hydrodynamic multi-surface spindle bearings
- Grinding wheel dimensions 2x Ø 500 x 100 mm (20 x 2.5 inch)
- High-frequency ID grinding spindles
- Min. 2 OD grinding wheels
- Max. 4 OD grinding wheels or 2–3 OD grinding wheels and 1 HF ID grinding spindle

The tandem-type wheelheads are designed for the possibility of carrying out straight and angular infeed operations in the same setting. With an additional HF internal grinding spindle it is possible to also process internal grinding work. The ideal equipment for these wheelheads can be determined by the nature of the workpieces to be ground.

HF ID GRINDING SPINDLES

- MFM 1224-42
- MFM 1242-60
- MFM 1290
- Frequency converter up to 3000 Hz

gSHAPE

Extension to the BLUE Solution, for programming a workpiece using design data (dxf). Graphical view of the workpiece & grinding wheel in 2D and 3D Automatic calculation of the grinding positions based on the contour information and automatic calculation of the grinding parameters.

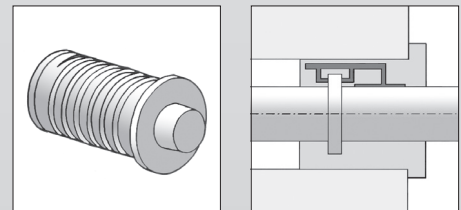
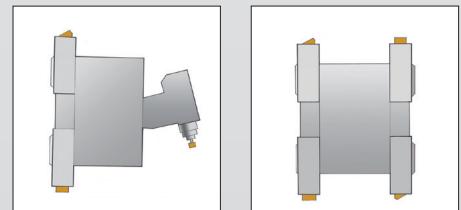
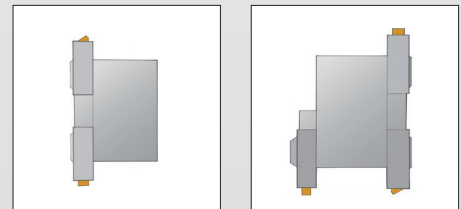
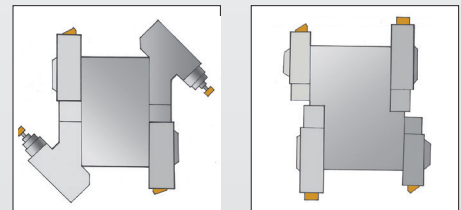
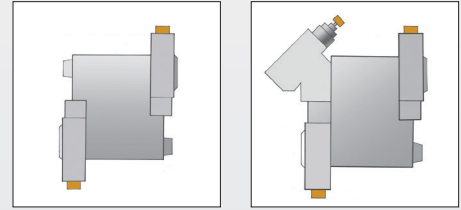

WATER-COOLED PRECISION-BALANCED DRIVE MOTORS

HYDRODYNAMIC MULTI-SURFACE SPINDLE BEARINGS

FANUC CONTROL 31i-B WITH KELLENBERGER HMI

The BLUE Solution user interface from KELLENBERGER has the central focus on simple and intuitive operation. All interactions are carried out by gestures on the 19" touch display. The latest generation of a reliable FANUC 31i-B control runs in the background.

BLUE SOLUTION

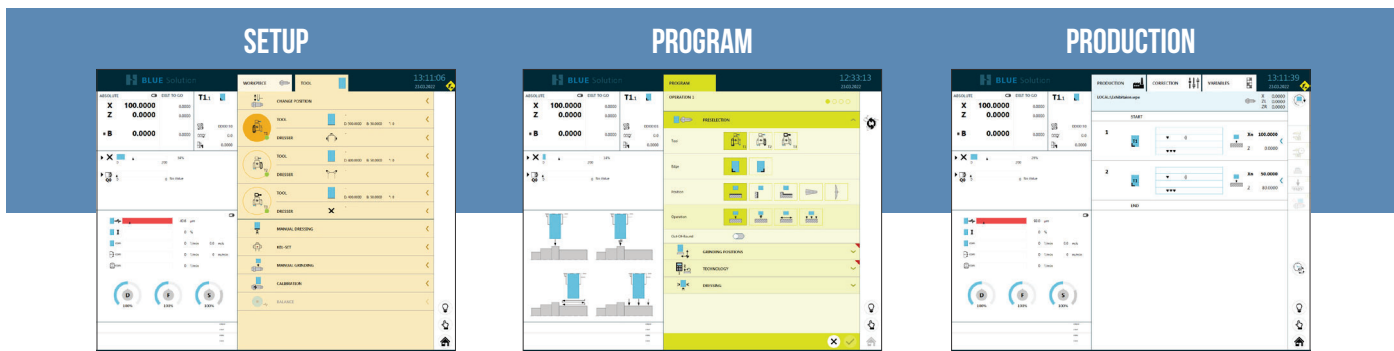

The user interface was developed explicitly for grinding by our specialists in cooperation with customers. BLUE Solution supports users regardless of their level of experience in all important steps from setup to production.

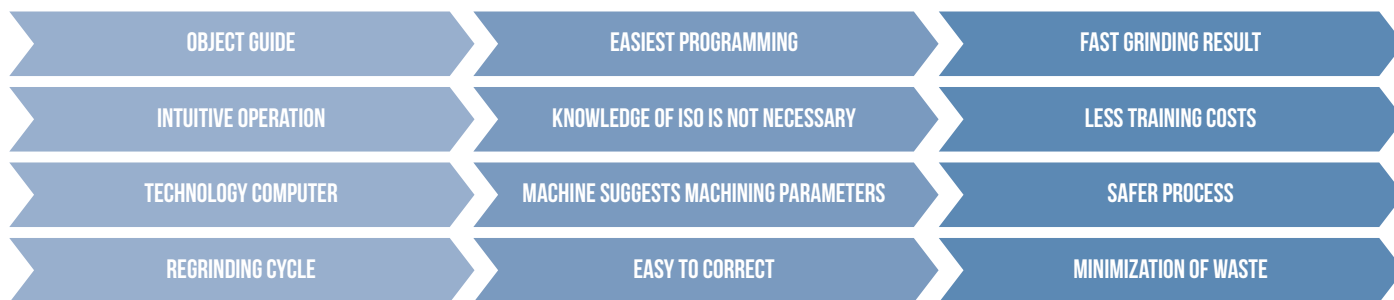

BLACK CAM SOLUTION

With the additional BLACK CAM Solution software, NC programs for grinding and dressing of profiles and threads can be generated, simulated and analyzed.

The CAD-CAM software supports the structured creation, processing and management of all documents belonging to a workpiece.

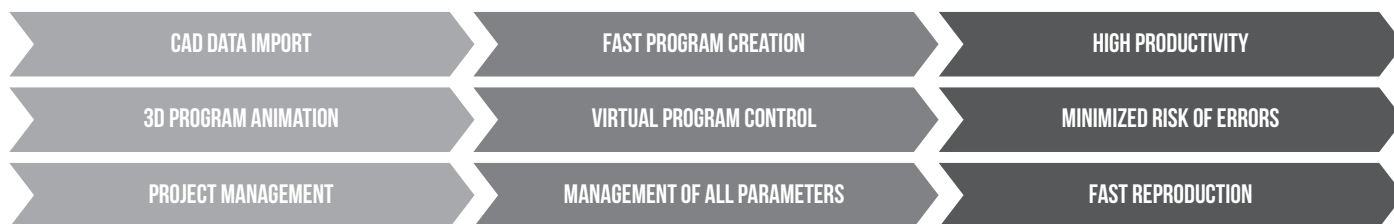
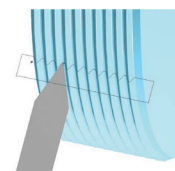

INDUSTRY 4.0

The Security Interface ensures communication according to the highest IT security standard between the machine and the production network.

The optional Remote Diagnostic module simplifies efficient diagnosis in case of service and thus reduces downtimes.

The machine is prepared for Industry 4.0. With the ComGateway, which has a standard OPC-UA server, extensive information on process and machine status can be exchanged.



TECHNICAL DATA

Main Specifications	Metric		Imperial	
Distance Between Centres	1000 / 1600	mm	40 / 63	inch
Grinding Length	1000 / 1500	mm	40 / 59	inch
Centre Height	200 / 250 / 300	mm	7.87 / 9.84 / 11.81	inch
Weight of Workpiece Between Centres	150 / 200 / 300	kg	330 / 441 / 660	lbs
Load on Chucked Work	160 / 320 / 750	Nm	118 / 236 / 553	lbft
Mains Voltage Required	3 x 400V / 50Hz / 3 x 460V / 60Hz		3 x 400V / 50 Hz / 3 x 460V / 60Hz	
Power Consumption Depending on Equipment	35-63 A	A	35-63 A	A
Space Required / Length x Width	3600 x 2050 / 4600 x 2050	mm	141.73x80.70 / 181.10x80.70	inch
Longitudinal Slides Z-Axis				
Travel	1170 / 1670	mm	46.06 / 65.74	inch
Rapid Traverse Speed	20	m/min	787	ipm
Resolution	0.00001	mm	0.000004	inch
Wheelslides X-Axis				
Travel	365	mm	14.37	inch
Rapid Traverse Speed	10	mm	393	inch
Resolution	0.00001	mm	0.000004	inch
B-Axis				
System Resolution / Repeatability	0.00001° < 0.5"		0.00001° < 0.5"	
Swiveling Range	max. 240		max. 240	
Wheelhead General				
Drive Motor Water-Cooled	10	kW	13.4	hp
Peripheral Grinding Wheel Speed	max: 45 m/s	m/s	max: 8860 ft/min	ft/min
Wheelhead Universal				
Grinding Wheel Dimensions, Lefthanded Side	400 / 500	mm	16 / 20	inch
Grinding Wheel Dimensions, Righthanded Side	300 / 400 / 500	mm	12 / 16 / 20	inch
Wheelhand Tandem-Type				
Grinding Wheel Dimensions, Lefthanded Side	400 / 500	mm	16 / 20	inch
Grinding Wheel Dimensions, Righthanded Side	400 / 500	mm	16 / 20	inch
Wheelhand Diagonal				
Grinding Wheel Dimensions, Lefthanded Side	400 / 500	mm	16 / 20	inch
Grinding Wheel Dimensions, Righthanded Side	400 / 500	mm	16 / 20	inch

TECHNICAL DATA

Internal Grinding Attachment				
Bore for Spindles Up to	mm	inch	120	4.72
HF Spindles MFM	kW	hp	10 / 15	13.4 / 20.1
Rotational Speed 1224 / 42	min-l	rpm	42,000	42,000
Rotational Speed 1242 / 60	min-l	rpm	60,000	60,000
Drehzahl MFM 1290	min-l	rpm	60,000	60,000
Rotational Spindle Speed	min-l	rpm	1-1000 / 1-1000 / 1-500	1-1000 / 1-1000 / 1-500
Internal Taper			MT5 / MT5 / MT6	MT5 / MT5 / MT6
Short Taper Holder, Outside			ISO 702-I : Size 5 / Size 5 / Size 8	ISO 702-I : Size 5 / Size 5 / Size 8
Micro-Adjustment	1'	arcmin	+/- 1.5	+/- 1.5
Tailstock				
Internal Taper			MT4	MT4
Retraction of Sleeve	mm	inch	49 optional 79	1.96 optional 3.15
Micro-Adjustment	µm	µinch	+/- 75	+/- 3
CNC Control System				
FANUC				FANUC 31i-B

All specifications and designs are subject to alterations without notice

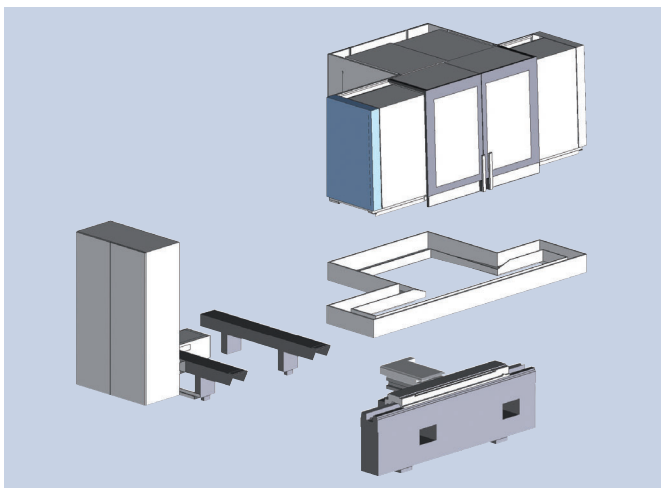

SEPARATE INFRASTRUCTURE



TRANSPORT

Efficient commissioning due to different lifting options

FLOOR PLAN

SPACE-ASSIGNMENT PLAN 1000

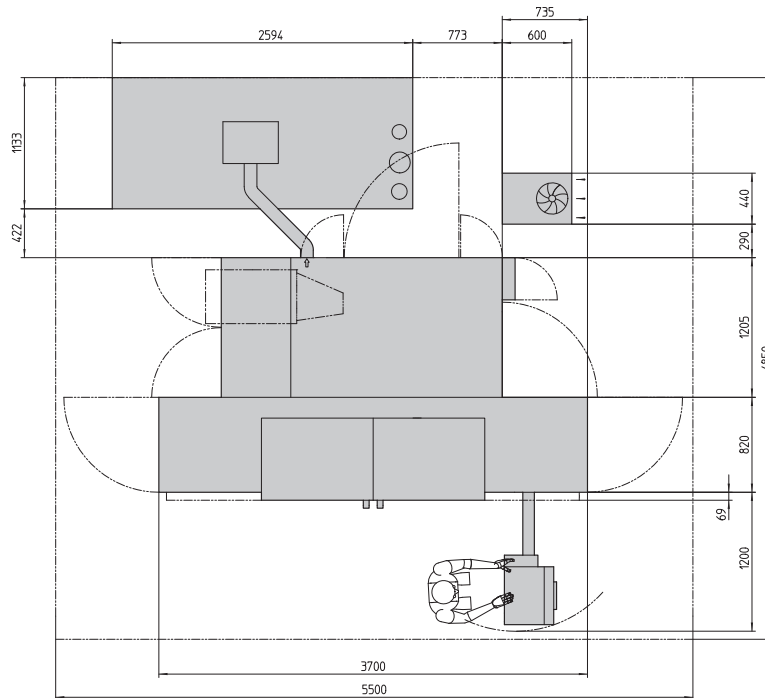

SPACE-ASSIGNMENT PLAN 1600

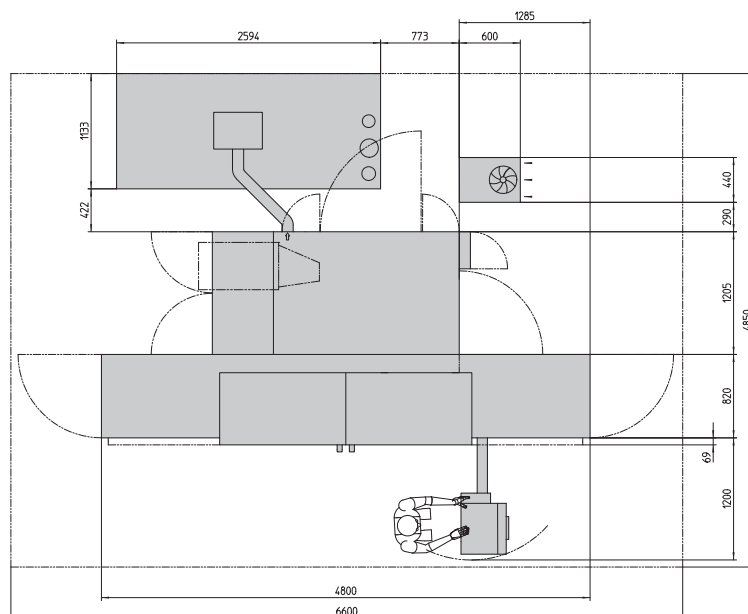



EUROPE & ASIA

Kellenberger Switzerland AG
Thannäckerstrasse 22
9403 Goldach
Tel. +41 71 242 91 11
info@kellenberger.net

AMERICA

Kellenberger Systems
1755 Britannia Drive, Unit A
Elgin, Illinois 60124
Tel. +800 8438801
info@kellenberger.net

CHINA

Kellenberger
1388 East Kang Qiao Road
Pudong, Shanghai 201319
Tel. +86 21 38108686
info@kellenberger.net

All prices and details are subject to change without notice. 1/2025